

Jia Chuan

SPECIFICATION FOR APPROVAL

CUSTOMER :
DESCRIPTION : AXIAL AC FAN
DIMENSIONS : 180x180x90mm
M O D E L : J118090HBL(T)
APPROVED NO :
(AUTHORIZED)
APPROVED BY :

DAWN.	CHKD.	APPD.	SPEC. NO.	
			ISSUE DATE	
			EDITION	
			REVISE DATE	
			E.SPEC	
Room812,6F.,No 80,Minzu 1st Rd., Sanmin Dist., Kaohsiung City 807, Taiwan Tel + 886-7-3802615 Fax + 886-7-3802315 Email: speciallyfan@gmail.com Website: www.specially-axialfan.com Skpe: Jiachuantw119				

Jia Chuan

AXIAL AC FAN

MODEL : J118090HBL(T)

CHARACTERISTICS

1. Motor Design : Capacitor start-run.
2. Insulation Resistance : 500Megohms minimum at 500 VDC.
3. Dielectric Strength : 1500 VAC for one minute.
4. Motor Protection : Capacitor protected & Class B
5. Noise Level : Measured in a semi-anechoic chamber with background noise level below 15 dB(A). The fan is running in free air with microphone at a distance of one meter from the fan intake.
6. Air Performance : Measured by a double chamber. The value are recorded when the fan speed is stabilized at rated voltage.
7. Tolerances : $\pm 15\%$ on rated power and current.

Jia Chuan Technology Ltd	SPEC. NO.	A120424	REVISE DATE	. 2005
	ISSUE DATE	3.25 2005	EDITION	
	PAGE	2 OF 6		

SPECIFICATIONS

MODEL: J118090HBL(T)

- 1-1. Rated Voltage : 115VAC 50/60hz**
- 1-2. Operating Voltage Range : 80-125VAC**
- 1-3. Starting Voltage : 80VAC**
- 1-4. Rated Speed : 2850/3400RPM**
- 1-5. Air Delivery : 390/460 CFM**
- 1-6. Static Pressure : 0.78/1.06 Inch-H₂O**
- 1-7. Rated Current : 0.88/0.63 AMP**
- 1-8. Input Power : 78/72 WATTS**
- 1-9. Noise Level : 54/59(A)**
- 1-10. Direction of Rotation : Counter-clockwise viewed front fan blade**
- 1-11. Motor Protection : Capacitor & Thermal Protected**
- 1-12. Operating Temperature : -10 to +80Deg.C**
- 1-13. Storage Temperature : -30 to +80Deg.C**
- 1-14. Bearing System : Precise ball bearing system**
- 1-15. Weight : 2200g**
- 1-16. Vibration : Vibration of acceleration 1.5G and Frequency 5~50~5Hz is applied in the 3 directions(X,Y,Z) for 30 minutes, each Direction at the cycle of 1 minute.**

Jia Chuan Technology Ltd	SPEC. NO.	A120424	REVISE DATE	11. 07. 2001
	ISSUE DATE	03.25 2005	EDITION	1
	PAGE	3 OF 6		

MODEL : J118090HBL(T)

Jia Chuan CURVES

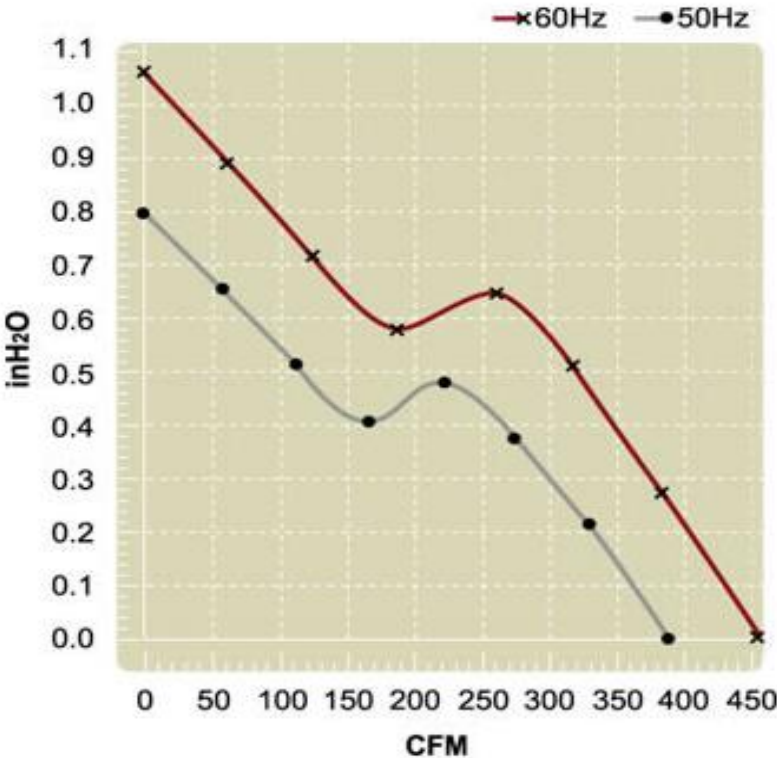

Jia Chuan Technology Ltd

Jia Chuan

Jia Chuan Technology Ltd.	SPEC. NO.	A120424	REVISE DATE	03. 25. 2005
	ISSUE DATE	03 252005	EDITION	1
	PAGE	4 OF 6		

MATERIAL

2. Material

2-1. Frame : DIE-CAST ALUMINUM

2-2. Impeller : Thermoplastic PBT of UL 94V-0

DIMENSIONS

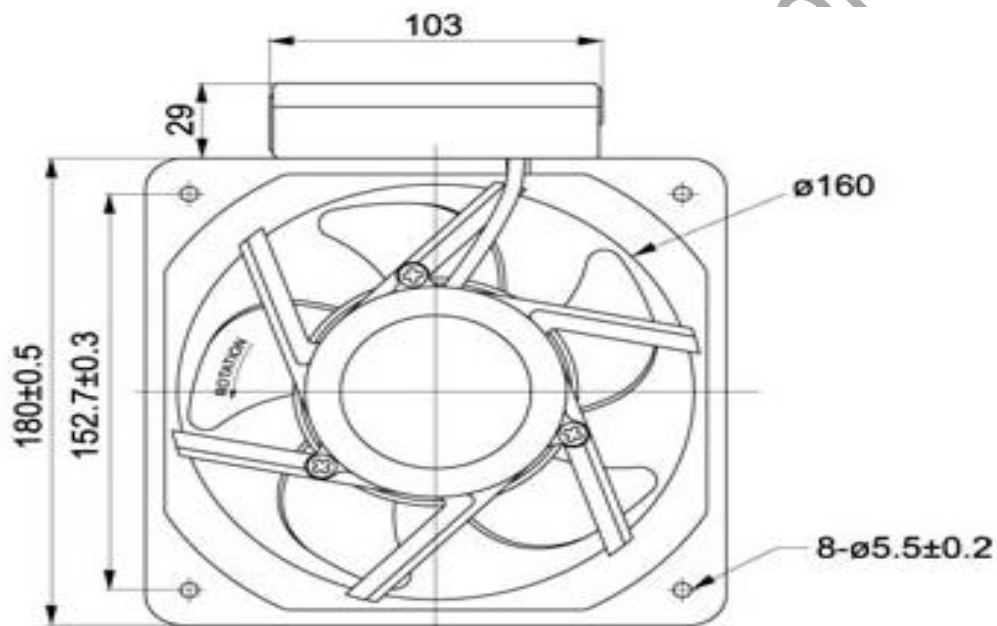

Terminal Box Type

Air Flow Direction: Label side.

UNITS: mm

Jia Chuan Technology Ltd	SPEC. NO.	A120424	REVISE DATE	03. 25. 2005
	ISSUE DATE	03 25 2005	EDITION	1
	PAGE	5 OF 6		

Notes

1. Jia Chuan eguarantee the products if the application conditions exceed those set out in this specification.
2. A written request should be submitted to Jia Chuan acceptance if deviation from this specification is required.
3. Caution should be exercised when handling the fan. Damages may be resulted when apply pressure to the impeller or hold the fan by the lead wires.
4. No guarantee on the products against the safety problem or failure caused by powder dust, drop of water or insect.
5. This specification sheet precedes all other information and should be used as the principal reference for the product to which it refers.
6. To satisfy the Profantec anagement Information System, please indicate SPEC. NO. on every order.
7. It is important that the correct polarity is established before connecting the fan to the electrical supply. Black (0V) , Red(+V). If cautions is not taken, immediate damage may occur on fans that do not have polarity protection.
8. fans are not suitable to be used in an environment that contains aggressive or corrosive fluids.
9. Always ensure that fans are stored according to the storage temperatures specified. Do not store in an environment with a high humidity level. If the fans were stored for longer than 6 months, it is highly recommended to apply functional testing before shipping.
10. Not all fans incorporate the Lock Rotor Protection feature. For fans that do not incorporate this feature it is important not to prevent the rotation of the impeller. Doing so, will lead to failure.
11. During installation, caution should be taken when mounting the fan. Incorrect mounting can cause excess resonance, vibration and noise.
12. During testing it is important to consider safety at all times. A suitable guard should be fitted to the fan to prevent personal injury.
13. Unless otherwise stated, all tests are carried out at relative temperature and humidity conditions of 25°C, 65%.

				03. 25. 2005
	ISSUE DATE	03 262005	E D I T I O N	1

Jia Chuan Technology Ltd